

Module GAUCHE

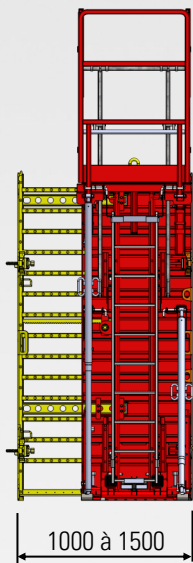

Module DROIT

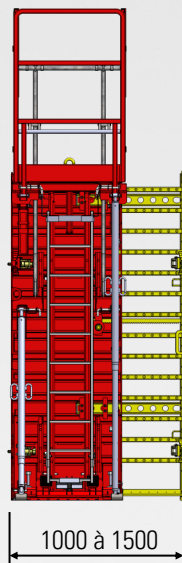

Largeur (m)	Hauteur (m)			
	2,8	1,5	1	0,5
1 à 1,5	✓	✓	✓	✓

Tableau des différents modules

- Poids moyen du coffrage: 170 kg/m² (banche 2,8 x 1,5)
 Sans bois ni contreplaqué
- Pression béton admissible: 10T/m²

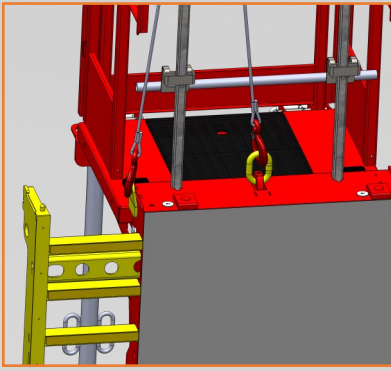

Levage vertical en 2 points.

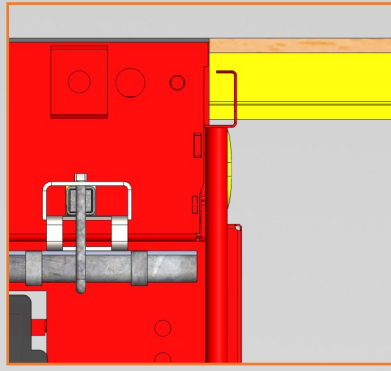

Contreplaqué epr=18mm affleurant avec tôle coffrante inox et filant pour côte bloquée

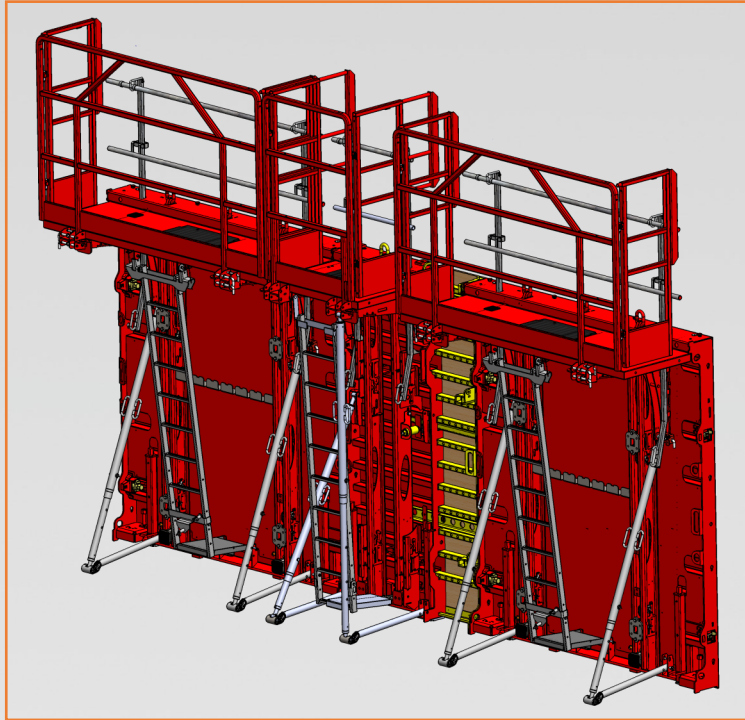
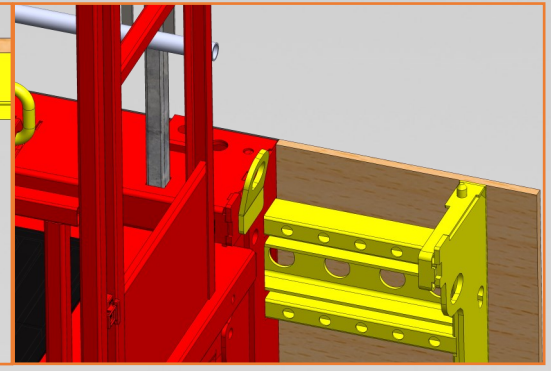

Liaison latérale compatible avec toute la gamme B10000

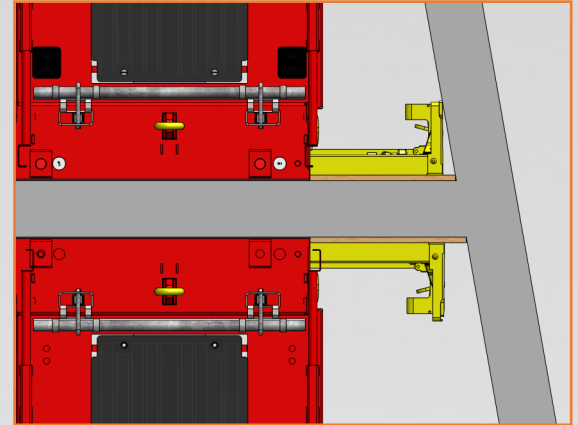

Utilisation en reprise de voile inclinée

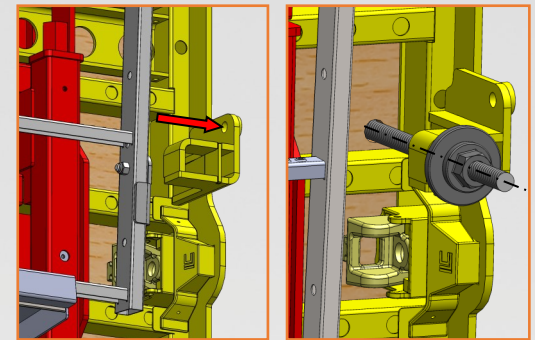

Support pour clamage et support pour entretoise

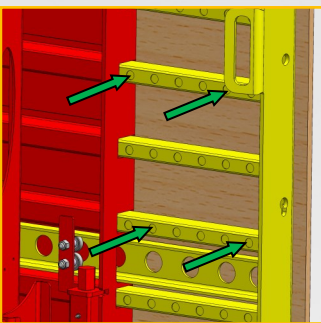

Fixation CP par l'arrière

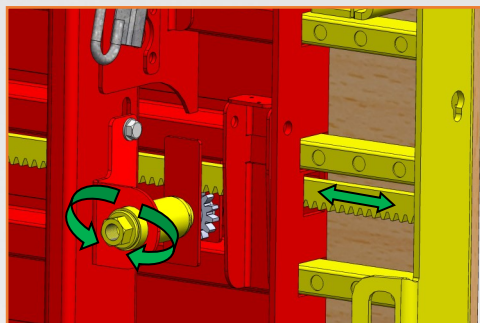

Déplacement extension par crémaillère

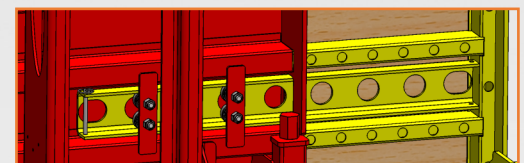

Rail de guidage sur roulements

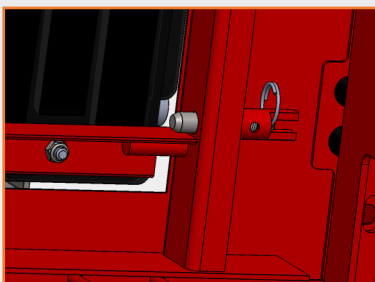

Ouverture trappe condamnable

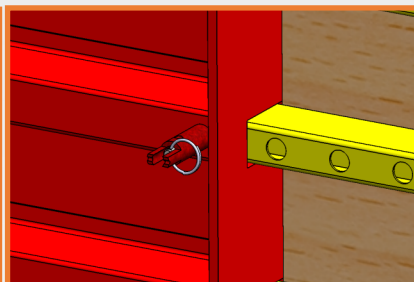

Anti-déboîtement extension

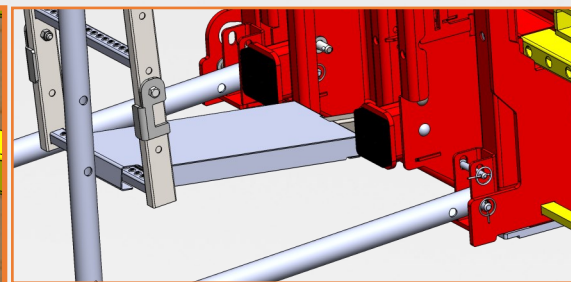

Banche équipée d'un palier d'échelle